

ILLUSTRATED PARTS LIST

CUSTOMER MODEL NUMBER P4056SM

PRODUCT NUMBER 961 11 00-06

MFG. ID. NUMBER 96111000600

ROTARY LAWN MOWER - - CUSTOMER MODEL NO. P4056SM (96111000600) PRODUCT NO. 961 11 00-06

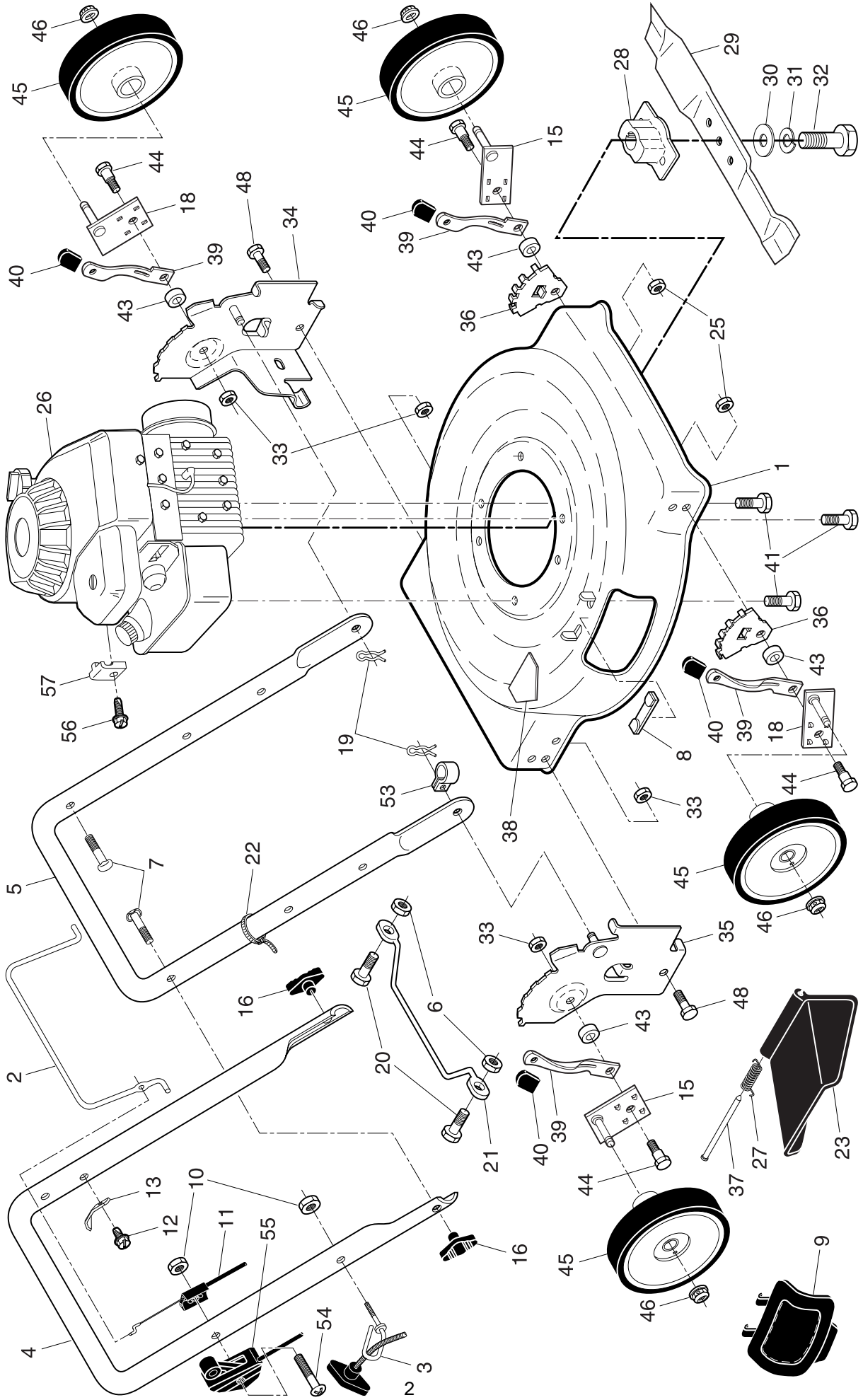

ROTARY LAWN MOWER - - CUSTOMER MODEL NO. P4056SM (9611100600) PRODUCT NO. 961 11 00-06

KEY NO.	PART NO.	DESCRIPTION	KEY NO.	PART NO.	DESCRIPTION
1	532 18 52-63	Lawn Mower Housing (Includes Key Number 38)	29	532 1411-14	22" Blade
2	532 19 55-74	Control Bar	30	532 8510-74	Hardened Washer
3	532 17 95-85	Rope Guide	31	532 8502-63	Helical Lockwasher 3/8
4	532 19 55-47	Upper Handle	32	532 8510-84	Hex Head Screw 3/8-24 x 1/4 Grade 8
5	532 17 42-91	Lower Handle	33	873 93 05-00	Locknut 5/16-18
6	532 06 91-80	Locknut, Hex 1/4-20	34	532 16 86-08	Wheel Bracket, Support, LH
7	532 19 15-74	Handle Bolt 5/16-18	35	532 16 86-09	Wheel Bracket, Support, RH
8	532 16 16-22	Clip, Closeout	36	532 16 57-04	Wheel Bracket, Adjuster
9	532 16 08-30	Plate, Mulcher	37	532 16 08-33	Hinge Rod
10	532 13 20-04	Nut, Hex	38	532 18 21-66	Danger Decal
11	532 13 31-07	Engine Zone Control Cable	39	532 16 85-99	Selector Spring
12	532 75 06-34	Hex Thread Rolling Screw #10-24 x1/2	40	532 08 78-77	Selector Knob
13	532 12 51-62	Up-Stop Bracket	41	532 15 04-06	Hex Head Thread Rolling Screw 3/8-16 x 1
15	532 18 92-77	Axle Arm Assembly (Rear, RH / Front, LH)	43	532 18 39-01	Washer
16	532 19 18-56	Handle Knob	44	532 16 08-28	Shoulder Bolt
18	532 18 92-78	Axle Arm Assembly (Rear, LH / Front, RH)	45	532 19 48-55	Wheel & Tire Assembly
19	532 05 17-93	Hairpin Cotter	46	532 08 39-23	Locknut, Hex 5/16-18
20	532 08 58-25	Hex Head Screw 1/4	48	817 60 04-06	Hex Head Bolt 5/16-18 x 3/4
21	532 15 41-47	Footguard	53	532 19 27-70	Clip, Cable
22	532 06 64-26	Wire Tie	54	532 18 33-65	Screw
23	532 16 08-31	Discharge Guard	55	532 17 02-97	Throttle Control
25	532 16 67-85	Nut, Hex	56	532 08 38-16	Screw
26	- - -	Engine, Briggs & Stratton, Model Number 10K902 (Order parts from engine manufacturer)	57	532 11 11-90	Clamp
27	532 19 34-36	Torsion Spring	- -	532 18 21-91	Warning Decal (not shown)
28	532 18 45-90	Blade Adapter	- -	532 19 56-67	Operator's Manual, European
			- -	532 19 56-69	Operator's Manual, Scandinavian

NOTE: All component dimensions given in U.S. inches. 1 inch = 25.4 mm. **IMPORTANT:** Use only Original Equipment Manufacturer (O.E.M.) replacement parts. Failure to do so could be hazardous, damage your lawn mower and void your warranty.